

A6 Series – Miniature Switches and Pilot Devices: 16mm

Key features:

- 16mm (5/8") mounting hole
- LED illumination
- Compact design saves space
- Momentary, Maintained, Selectors, and E-Stops
- Gold-clad Silver contacts for reliable low level switching
- Snap action contacts
- IP40 (dustproof) or IP65 (oiltight) versions



UL Recognized
File No. E55996



CSA Certified
File No. LR21451



Specifications	Degree of Protection	IP40: Dustproof IP65 Watertight/Oiltight			
	Contact Configuration	SPDT, DPDT			
	Maximum Voltage	250V AC/DC			
	Thermal Current	3A			
	Minimum Applicable Load	5V AC/DC, 1mA			
	Contact Material	Gold-clad silver			
	Terminal Style	.110" Solder/ Quick Connect			
	Operating Temperature	-25° to +55°C (no freezing)			
	Operating Humidity	45 to 85% RH			
	Contact Resistance	50mΩ maximum (initial value)			
	Insulation Resistance	100MΩ minimum (500V DC megger)			
	Vibration Resistance	10 to 55Hz, amplitude 1.5mm p-p			
	Shock Resistance	Damage limits: 500m/sec ² (approx. 50G) Operating extremes: 200m/sec ² (approx. 20G)			
Electrical Life	100,000 operations minimum (at full rated load)				
Mechanical Life	Maintained: 100,000 operations minimum Momentary: 1,000,000 operations minimum Selector/Keylock: 250,000 operations minimum				
Dielectric Strength	Switch Unit: 2,000V AC, 1 min. between live/dead part and terminals of different poles; 1,000V AC, 1 minute between terminals of the same pole; 1,500V AC, 1 minute between contact and lamp terminals. Illumination Unit: 2,000V AC, 1 min. between live part/ground				
Soldering Temperature	20W/5 seconds or 260°C/3 seconds				
Contact Ratings	Operating Voltage	24V	120V	240V	
	AC (50/60Hz)	Resistive	—	1.0A	0.5A
		Inductive	—	0.7A	0.5A
	DC	Resistive	1.0A	0.2A	—
Inductive		0.7A	0.1A	—	
LED Lamp Ratings	Rated Voltage/Current	5V DC ±5%	6V AC/DC (±10%)	12V AC/DC (±10%)	24V AC/DC (±10%)
		8mA	AC: A, R, W, Y: 8mA G, S: 7mA DC: A, R, W, Y: 6mA G, S: 5mA	AC: 9mA DC: 8mA	AC: 9mA DC: 8mA



1. AC Inductive Load, PF = 0.6 – 0.7; DC Inductive Load, L/R = 7ms.
2. LED lamp contains a built-in current limiting resistor and a protection diode.
3. LED's don't "burn out." Luminance is reduced to 50% of initial intensity after being lit for 50,000 hours continuously.

Switches & Pilot Lights

Display Lights

Relays & Sockets

Timers

Terminal Blocks

Circuit Breakers

AB6 Non-Illuminated Pushbuttons (Assembled)

Non-Illuminated Pushbuttons

Style	Contact	Part Number			
		Momentary		Maintained (Latching)	
		Dustproof (IP40)	Oiltight (IP65)	Dustproof (IP40)	Oiltight (IP65)
Round 18mm 	SPDT DPDT	AB6M-M1-Ⓞ AB6M-M2-Ⓞ	AB6M-M1P-Ⓞ AB6M-M2P-Ⓞ	AB6M-A1-Ⓞ AB6M-A2-Ⓞ	AB6M-A1P-Ⓞ AB6M-A2P-Ⓞ
Square 18mm 	SPDT DPDT	AB6Q-M1-Ⓞ AB6Q-M2-Ⓞ	AB6Q-M1P-Ⓞ AB6Q-M2P-Ⓞ	AB6Q-A1-Ⓞ AB6Q-A2-Ⓞ	AB6Q-A1P-Ⓞ AB6Q-A2P-Ⓞ
Rectangular 18mm x 24mm 	SPDT DPDT	AB6H-M1-Ⓞ AB6H-M2-Ⓞ	AB6H-M1P-Ⓞ AB6H-M2P-Ⓞ	AB6H-A1-Ⓞ AB6H-A2-Ⓞ	AB6H-A1P-Ⓞ AB6H-A2P-Ⓞ
Round 23.5mm 	SPDT DPDT	-	AB6M-M1P-MⓄ AB6M-M2P-MⓄ	-	AB6M-A1P-MⓄ AB6M-A2P-MⓄ
Square 23.5mm 	SPDT DPDT	-	AB6Q-M1P-QⓄ AB6Q-M2P-QⓄ	-	AB6Q-A1P-QⓄ AB6Q-A2P-QⓄ
Rectangular 17.5 X 23.5mm 	SPDT DPDT	-	AB6Q-M1P-HⓄ AB6Q-M2P-HⓄ	-	AB6Q-A1P-HⓄ AB6Q-A2P-HⓄ

Ⓞ Button Color Code

Color	Code
Black	B
Green	G
Red	R
Blue	S
White	W
Yellow	Y



1. In place of Ⓞ, specify Button Color Code from the table at right.
2. To order as sub-assembled, see page 459.
3. For accessories, see page 466.
4. For dimensions, see page 468.

AB6-V Pushlock Turn Reset

Shape	Operation	Contact	Part Number		Remarks
			Dustproof (IP40)	Oiltight (IP65)	
23.5mm Round Mushroom 	Pushlock Turn Reset	SPDT DPDT	AB6M-V1-R AB6M-V2-R	AB6M-V1P-R AB6M-V2P-R	1. Button available in red only. 2. Replacement button: order AB6M-V-R

Buzzer

Style	Shape	Voltage	Part Number
	Round (18mm)	12V DC	UZ6-11
		24V DC	UZ6-12

Buzzer Ratings

Frequency	2 kHz ± 500 Hz
Amplitude	80db @ 0.1m (at rated voltage)
Operating Voltage	6V AC/DC or 12 - 24V AC/DC ± 10%
Adjustable Cycle	55 to 600 cycles per minute
Current Draw	DC: 7mA, AC: 20mA
Life	1000 hrs. minimum
Insulation Voltage	60V AC/DC
Operating Temperature	-20 to 55 C (no freezing), 45 to 85% rh

Switches & Pilot Lights

Display Lights

Relays & Sockets

Timers

Terminal Blocks

Circuit Breakers

AB6 Non-Illuminated Pushbuttons (Sub-Assembled)



Operators

Style	Contact	Operator	Part Number		
			Round	Square	Rectangular
Non-Illuminated Pushbuttons 	SPDT	Momentary	AB6M-M100	AB6Q-M100	AB6H-M100
		Maintained	AB6M-A100	AB6Q-A100	AB6H-A100
	DPDT	Momentary	AB6M-M200	AB6Q-M200	AB6H-M200
		Maintained	AB6M-A200	AB6Q-A200	AB6H-A200

 Oversize rectangular button uses square operator.

Buttons

Description	Part Number	
	Button	
	Dustproof (IP40)	Oiltight (IP65)
Round 	AB6M-BK1-①	AB6M-BK2-①
Square 	AB6Q-BK1-①	AB6Q-BK2-①
Rectangular 	AB6H-BK1-①	AB6H-BK2-①
Round Oversize 	—	AB6M-BK2-M①
Square Oversize 	—	AB6Q-BK2-Q①
Rectangular Oversize 	—	AB6Q-BK2-H①

① Button Color Code

Color	Code
Black	B
Green	G
Red	R
Blue	S
White	W
Yellow	Y

-  1. In place of ①, specify Button Color Code from table.
 2. Buttons which are rated IP65 include a waterproof rubber gasket.
 3. For accessories, see page 466.

AL6 Illuminated Pushbuttons (Assembled)

LED Illuminated Pushbuttons

Description	Style	Contact	Part Numbers			
			Momentary		Maintained (Latching)	
			Dustproof (IP40)	Oiltight (IP65)	Dustproof (IP40)	Oiltight (IP65)
Standard Lens 	Round (18mm lens)	SPDT DPDT	AL6M-M1③-② AL6M-M2③-②	AL6M-M1③P-② AL6M-M2③P-②	AL6M-A1③-② AL6M-A2③-②	AL6M-A1③P-② AL6M-A2③P-②
	Square (18mm lens)	SPDT DPDT	AL6Q-M1③-② AL6Q-M2③-②	AL6Q-M1③P-② AL6Q-M2③P-②	AL6Q-A1③-② AL6Q-A2③-②	AL6Q-A1③P-② AL6Q-A2③P-②
	Rectangular (18mm x 24mm lens)	SPDT DPDT	AL6H-M1③-② AL6H-M2③-②	AL6H-M1③P-② AL6H-M2③P-②	AL6H-A1③-② AL6H-A2③-②	AL6H-A1③P-② AL6H-A2③P-②
Oversize Lens 	Round (24mm lens)	SPDT DPDT	-	AL6M-M1③P-M② AL6M-M2③P-M②	-	AL6M-A1③P-M② AL6M-A2③P-M②
	Square (24mm lens)	SPDT DPDT	-	AL6Q-M1③P-Q② AL6Q-M2③P-Q②	-	AL6Q-A1③P-Q② AL6Q-A2③P-Q②
	Rectangular (18mm x 24mm lens)	SPDT DPDT	-	AL6Q-M1③P-H② AL6Q-M2③P-H②	-	AL6Q-A1③P-H② AL6Q-A2③P-H②

- 1. In place of ②, specify Lens/LED Color Code from table below.
- 2. In place of ③, specify Voltage Code from table below.
- 3. Lamps also available in 5V DC, 6V AC/DC or 12 V AC/DC, change "4" using voltage/lamp codes (ie AL6M-M13-② uses 12V AC/DC LED).
- 4. LED lamp is included in unit and contains a current-limiting resistor and a protection diode. (External resistor not required.)
- 5. To order as sub-assembled, see page 461.
- 6. For accessories, see page 466.
- 7. For dimensions, see page 468.
- 8. Light independent of switch position.

② Lens/LED Color Code

Color	Code
Amber	A
Green	G
Red	R
Blue	S
Warm White	W
Cool White	JW
Yellow	Y

③ Voltage Code

Voltage	Code
5V DC	1
6V AC/DC	2
12V AC/DC	3
24V AC/DC	4

Switches & Pilot Lights
Display Lights
Relays & Sockets
Timers
Terminal Blocks
Circuit Breakers

AL6 Illuminated Pushbuttons (Sub-Assembled)

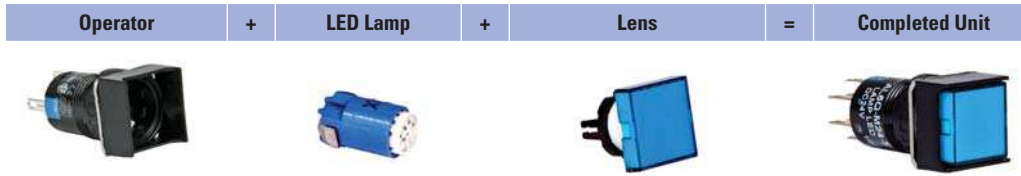

Operators

Style	Contact	Operator	Part Number		
			Round	Square	Rectangular
AL6 Illuminated Pushbuttons 	SPDT	Momentary	AL6M-M100	AL6Q-M100	AL6H-M100
		Maintained	AL6M-A100	AL6Q-A100	AL6H-A100
	DPDT	Momentary	AL6M-M200	AL6Q-M200	AL6H-M200
		Maintained	AL6M-A200	AL6Q-A200	AL6H-A200

Oversize rectangular button uses square operator.

Lenses

Unit	Part Number		
	Dustproof (IP40)	Oiltight (IP65)	
	Standard	Standard	Oversize
Round	AL6M-LK1-Ⓢ 	AL6M-LK2-Ⓢ 	AL6M-LK2-M Ⓢ
Square	AL6Q-LK1-Ⓢ 	AL6Q-LK2-Ⓢ 	AL6Q-LK2-Q Ⓢ
Rectangular	AL6H-LK1-Ⓢ 	AL6H-LK2-Ⓢ 	AL6Q-LK2-H Ⓢ

- 1. In place of Ⓢ, specify Lens Color Code from table below.
- 2. Lenses which are rated IP65 include a waterproof rubber gasket.
- 3. For accessories, see page 466.

Ⓢ Lens/LED Color Code

Color	Code
Amber	A
Green	G
Red	R
Blue	S
Warm White	W
Cool White	JW
Yellow	Y

LED Lamps

Appearance	Rated Voltage	Part Number
	5V DC	LATD-5 Ⓢ
	6V AC/DC	LATD-6 Ⓢ
	12V AC/DC	LATD-1 Ⓢ
	24V AC/DC	LATD-2 Ⓢ

- 1. In place of Ⓢ, specify LED Color Code from table at left.

AL6 Pilot Lights (Assembled)

LED Pilot Lights

Description	Part Number	
	Dustproof (IP40)	Oiltight (IP65)
Round (18mm Lens) 	AL6M-P③-②	AL6M-P③P-②
Square (18mm Lens) 	AL6Q-P③-②	AL6Q-P③P-②
Rectangular (18mm x 24mm Lens) 	AL6H-P③-②	AL6H-P③P-②

- ⚠ 1. In place of ②, specify Lens Color Code from table below.
- 2. In place of ③, specify Voltage Code from table below.
- 3. LEDs also available in 5V DC, 6V AC/DC or 12V AC/DC, change "4" using voltage codes (ie AL6M-P3-② uses 12V AC/DC LED).
- 4. LED is included and contains built-in current limiting resistor and reverse polarity protection diode. (no external resistor required)
- 5. To order sub-assembled, see page 463.
- 6. For accessories, see page 466.
- 7. For dimensions, see page 468.
- 8. For one piece pilot lights and/or dome lens pilot lights, see AP series miniature pilot lights.

② Lens/LED Color Code

Color	Code
Amber	A
Green	G
Red	R
Blue	S
Warm White	W
Cool White	JW
Yellow	Y

③ Voltage Code

Voltage	Code
5V DC	1
6V AC/DC	2
12V AC/DC	3
24V AC/DC	4

Switches & Pilot Lights

Display Lights

Relays & Sockets

Timers

Terminal Blocks

Circuit Breakers

AL6 Pilot Lights (Sub-Assembled)



Operators

Style	Part Number		
	Round	Square	Rectangular
AL6 Pilot Lights 	AL6M-P00	AL6Q-P00	AL6H-P00

Lenses

Degree of Protection	Part Number	
	Dustproof IP40	Oiltight IP65
Round	AL6M-LK1-Ⓢ 	AL6M-LK3-Ⓢ
Square	AL6Q-LK1-Ⓢ 	AL6Q-LK3-Ⓢ
Rectangular	AL6H-LK1-Ⓢ 	AL6H-LK3-Ⓢ

- 1. In place of Ⓢ, specify Lens Color Code from table below.
- 2. Lenses which are rated IP65 include a waterproof rubber gasket.
- 3. For accessories, see page 466.

Ⓢ Lens/LED Color Code

Color	Code
Amber	A
Green	G
Red	R
Blue	S
Warm White	W
Cool White	JW
Yellow	Y

LED Lamps

Appearance	Rated Voltage	Part Number
	5V DC	LATD-5 Ⓢ
	6V AC/DC	LATD-6 Ⓢ
	12V AC/DC	LATD-1 Ⓢ
	24V AC/DC	LATD-2 Ⓢ

- 1. In place of Ⓢ, specify LED Color Code from table at left.

Switches & Pilot Lights

Display Lights

Relays & Sockets

Timers

Terminal Blocks



Circuit Breakers

AS6 Selector and Keylock Switches

AS6 Selector Switches and Keylock Switches (2 & 3 Position)

Style	Function	Knob	Key	
Round Selector 	2-Position 90° Maintained		AS6M-2Y2P	AS6M-2KT2PⓄ
	2-Position 90° Spring Return Right		AS6M-21Y2P	AS6M-21KT2PB
Round Keylock 	3-Position 45° Maintained		AS6M-3Y2P	AS6M-3KT2PⓄ
	3-Position 45° Spring Return Right → Center		AS6M-31Y2P	AS6M-31KT2PⓄ
	3-Position 45° Spring Return Left → Center		AS6M-32Y2P	AS6M-32KT2PⓄ
Square Selector 	2-Position 90° Maintained		AS6Q-2Y2P	AS6Q-2KT2PⓄ
	2-Position 90° Spring Return to Right		AS6Q-21Y2P	AS6Q-21KT2PB
	Square Keylock 	3-Position 45° Maintained		AS6Q-3Y2P
3-Position 45° Spring Return Right → Center			AS6Q-31Y2P	AS6Q-31KT2PⓄ
3-Position 45° Spring Return Left → Center			AS6Q-32Y2P	AS6Q-32KT2PⓄ
Rectangular Selector 	2-Position 90° Maintained		AS6H-2Y2P	AS6H-2KT2PⓄ
	2-Position 90° Spring Return Right		AS6H-21Y2P	AS6H-21KT2PB
	Rectangular Keylock 	3-Position 45° Maintained		AS6H-3Y2P
3-Position 45° Spring Return Right → Center			AS6H-31Y2P	AS6H-31KT2PⓄ
3-Position 45° Spring Return Left → Center			AS6H-32Y2P	AS6H-32KT2PⓄ
Rectangular Keylock 	3-Position 45° 2-Way Return → Center		AS6H-33Y2P	AS6H-33KT2PD

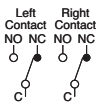
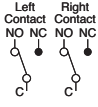
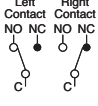
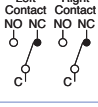
Contact Operations (for all selectors)

Contents	Operator Position & Contact Operation
2-pos. (DPDT)	Left 
	Right 
3-pos. (DPDT)	Left 
	Center 
	Right 

Key Retention Codes

Code	Description
A	Key not retained in any position (removable in all positions)
B	Key retained in right position only
C	Key retained in left position only
D	Key retained in left and right (3 position only)
E	Key retained in center only (3 position only)
G	Key retained right and center (3 position only)
H	Key retained left and center (3 position only)

 Key cannot be removed in a spring return position.

- All models are IP65 and DPDT.
- In place of Ⓞ, specify Key Retention Code. See table on right.
- Available as assembled units only.
- For accessories, see page 466.
- For dimensions, see page 468.

Switches & Pilot Lights

Display Lights

Relays & Sockets

Timers

Terminal Blocks

Circuit Breakers

Switch Engraving Order Form – A6 Series

Copy this order form and use it to specify Letter Height, Maximum Number of Lines and Text to be engraved.

To insure engraving accuracy, fax it to your IDEC representative or Distributor.

Your Company: _____
 Name: _____
 Address: _____
 PO: _____

Telephone: _____
 Fax: _____
 Email: _____
 Part Number to be Engraved: _____

Please check one of the boxes below to indicate your choice of engraving options:

Rectangular Switch

	# of Lines	Letter Height	Max. Characters Per Line
<input type="checkbox"/>	1	5/32	6
<input type="checkbox"/>	2	5/32	6
<input type="checkbox"/>		1/8	6
<input type="checkbox"/>	3	1/8	6
<input type="checkbox"/>	4	N/A	

Square Switch

	# of Lines	Letter Height	Max. Characters Per Line
<input type="checkbox"/>	1	5/32	5
<input type="checkbox"/>	2	5/32	5
<input type="checkbox"/>		1/8	6
<input type="checkbox"/>	3	1/8	6
<input type="checkbox"/>	4	N/A	

Round Switch

	# of Lines	Letter Height	Max. Characters Per Line
<input type="checkbox"/>	1	5/32	3
<input type="checkbox"/>		1/8	3
<input type="checkbox"/>	2	5/32	Custom*
<input type="checkbox"/>	3	1/8	Custom*
<input type="checkbox"/>	4	3/32	Custom*

*Engraving is possible, but character size will be smaller than standard sizes.



1. Engraving is done on the button itself for non-Illuminated pushbuttons and on marking plate for illuminated pushbuttons and pilot lights.
2. Please enter text exactly how you want it engraved, take care to emphasize capital or small letters.

Enter text to be engraved:

Line 1: _____
 Line 2: _____
 Line 3: _____
 Line 4: _____

Sample Letter Sizes

1/8 Letters: **OPEN**

5/32 Letters: **OPEN**

For IDEC Internal Use Only:

Work Order #: _____

Accessories
Switches & Pilot Lights
Display Lights
Relays & Sockets
Timers
Terminal Blocks
Circuit Breakers

Appearance		Description	Used With	Part Number
Locking Ring Wrench		Made of metal. Used for tightening plastic locking ring during installation. Tightening torque should not exceed 3kgf-cm	Ø 5/8" (16mm) units	MT-001
			Ø 31/64" (12mm) AP2M units	MT-002
			Ø 13/32" (10mm) AP1M units	MT-003
Lens Removal Tool		Made of metal. Used for removing lens or button from the housing	All pushbuttons and pilot lights	MT-101
Lamp Holder Tool		Made of rubber. Used for removing and replacing LED lamps in illuminated units	All illuminated pushbuttons and pilot lights	OR-77
Switch Guard		Prevents inadvertent switch operation. IP40 dust-tight. 90 degrees opening maintained	Round/Square	AL-K6
			Rectangular	AL-KH6
			Prevents inadvertent switch operation. IP65 oiltight 180 degrees opening, spring return	Round/Square
			Rectangular	AL-KH6SP
Terminal Cover		Made of translucent nylon. Fits over and shields the terminals	All 5/8" (16mm) units	AL-V6
Dust Cover		Fits over the lens or button to provide extra protection from dust (not applicable for oversize lenses or buttons).	All round units	AL-D6
			All square units	AL-DQ6
			All rectangular units	AL-DH6
Adaptor Socket		Plug-on terminal adaptor with solder terminals		AL-C6
		Plug-on terminal adaptor with PCB terminals	All 5/8" (16mm) units	AL-C6V
Mounting Hole Plug		Fills unused panel cutouts. Made of nitrile rubber. Push-in installation from front of panel. IP65 (oiltight).	Rubber	AL-B6
		Fills unused panel cutouts. Made of aluminum. Screw-on locking ring from inside of panel. IP65 (oiltight).	Aluminum	AL-BM6
		Round Mounting Hole Plug	Plastic (Applicable for flush mount switches only)	LA9Z-BS6
		Square Mounting Hole Plug		LA9Z-BS7
		Rectangular Mounting Hole Plug		LA9Z-BS8
Replacement LED Lamps		LED with built in current limiting resistor (with all illuminated assemblies).	5V DC	LATD-5 ☉
			6V AC/DC	LATD-6 ☉
			12V AC/DC	LATD-1 ☉
			24V AC/DC	LATD-2 ☉
Replacement Locking Ring		Fastens operators to panel (included with all operators).	All switches & pilot lights	HA9Z-LN
Anti-Rotation Ring		Prevents rotation of switches in panel (included with all operators).	All switches & pilot lights	AL6-LP
Replacement Engraving Inserts		Engraving plates to allow legends underneath translucent lenses (included with all lenses).	Round standard	AL6M-W
			Square standard	AL6Q-W
			Rectangular standard	AL6H-W
			Round oversize	AL6M-MW
			Square/rectangular oversize	AL6Q-QW
Replacement Keys		Pair of keys (#132). All key switches use same standard key.	All key selectors	AS6-SK

1. In place of ☉ specify color code. A=Amber, G=Green, Y=Yellow, R=Red, S=Blue, W=Warm White, JW=Cool White.
2. LEDs include built-in current limiting resistor and reverse polarity protection diode.

Appearance	Description	Used With	Part Number
Flush Bezel	ø24mm round, metal (aluminum color), panel cut-out ø20.2mm	Pushbuttons, pilot lights, illuminated pushbutton, selector switches, key selector switches and illuminated selector switches.	LA9Z-SM61
	ø24mm round, plastic (black), square panel cut-out ø20.2mm	A6 Switch	LA9Z-S61B
	24mm square, plastic (black), panel cut-out 20.2 x 20.2mm	Flush Bezel	LA9Z-S71B
	24 x 30mm rectangular, plastic (black), rectangular panel cut-out ø20.2 x 26.2mm	Flush Bezel	LA9Z-S81B
Switch Guard w/ Flush Bezel (spring return)	Rectangular, plastic (black)	Flush Switch	LA9Z-KS8

Switches & Pilot Lights

Display Lights

Relays & Sockets

Timers

Terminal Blocks

Circuit Breakers

Schematics — A Series: 5/8" (16mm)

Terminal Arrangement (Top View)

Illuminated Pushbuttons

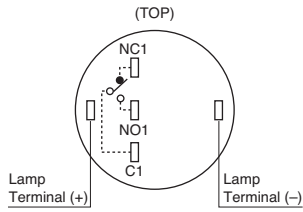

SPDT Contact (Single-pole/Double Throw)

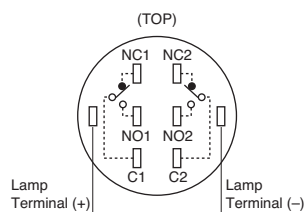

DPDT Contact (Double-pole/Double Throw)

Non-illuminated Pushbuttons and Selector Switches

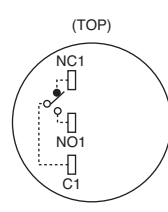

SPDT Contact (Single-pole/Double Throw)

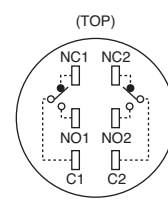

DPDT Contact (Double-pole/Double Throw)

Pilot Lights

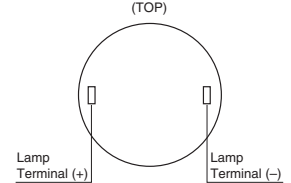

IDEC's Superbright LED Internal Circuits

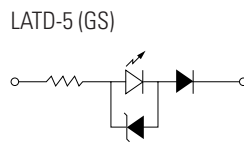
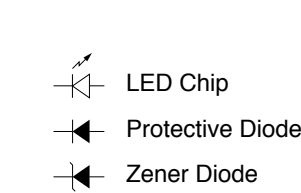
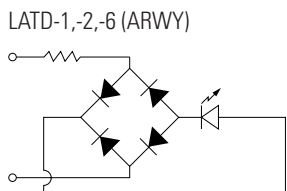
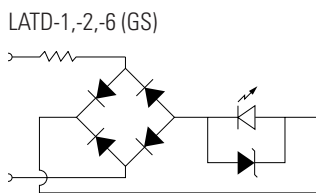

Dimensions (mm)

Pushbuttons, Ø 5/8" (16mm)

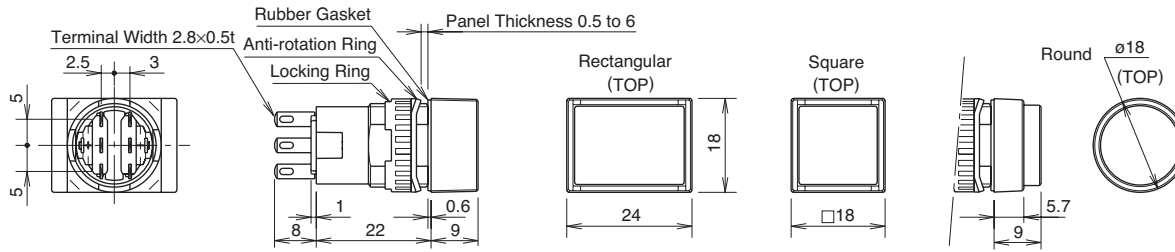

Oversize Lens

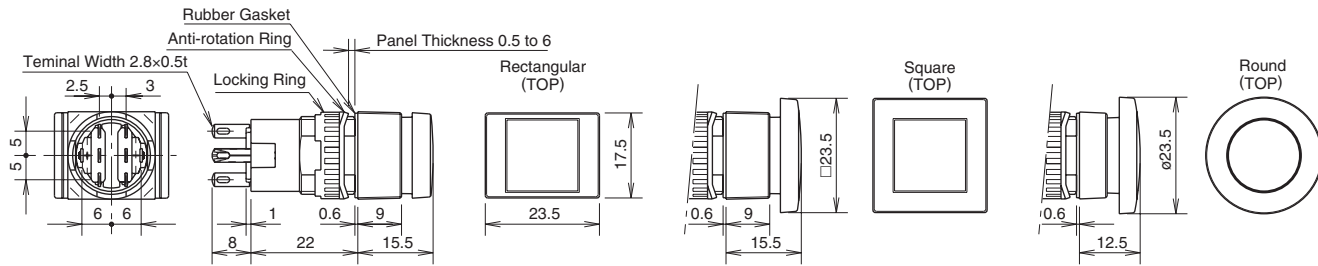

Selector Switches, Ø 5/8" (16mm)

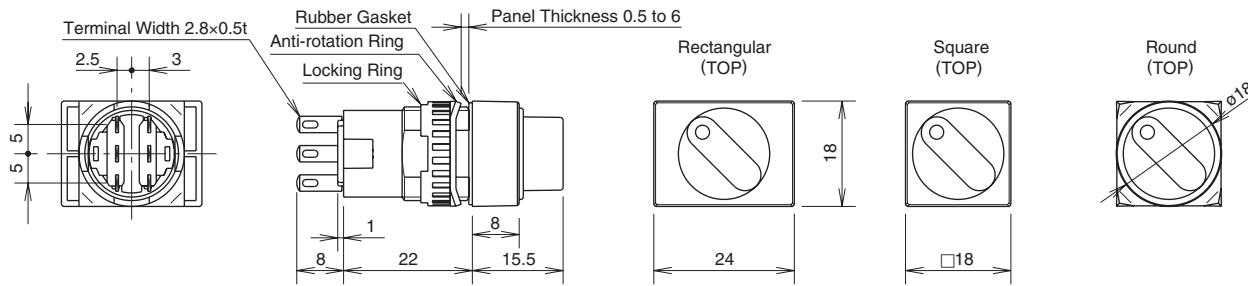

Key Selector Switches, Ø 5/8" (16mm)

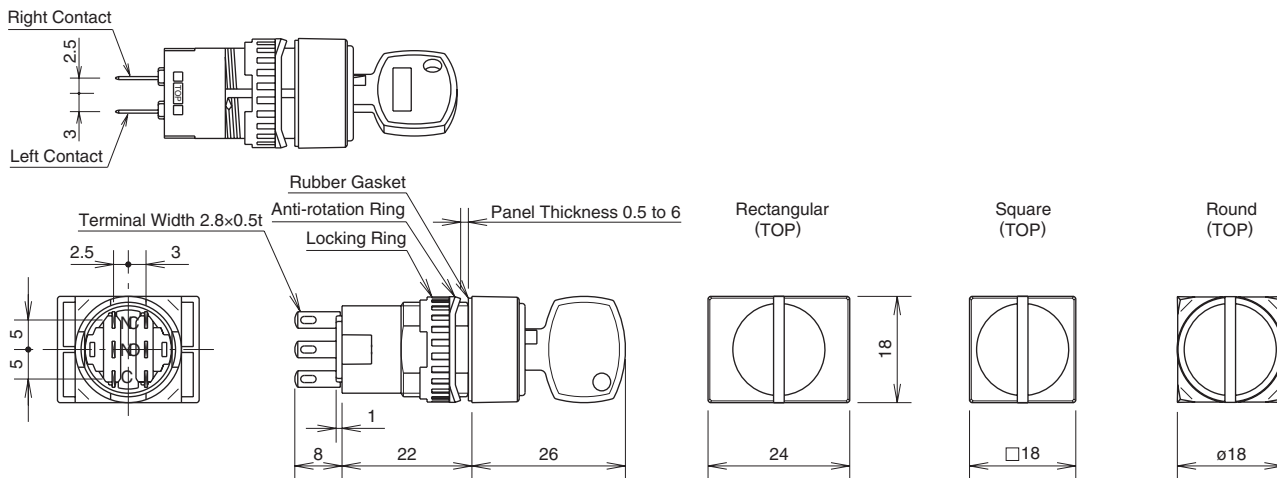

Switches & Pilot Lights

Display Lights

Relays & Sockets

Timers

Terminal Blocks

Circuit Breakers

Switch Guard, Ø 5/8" (16mm)

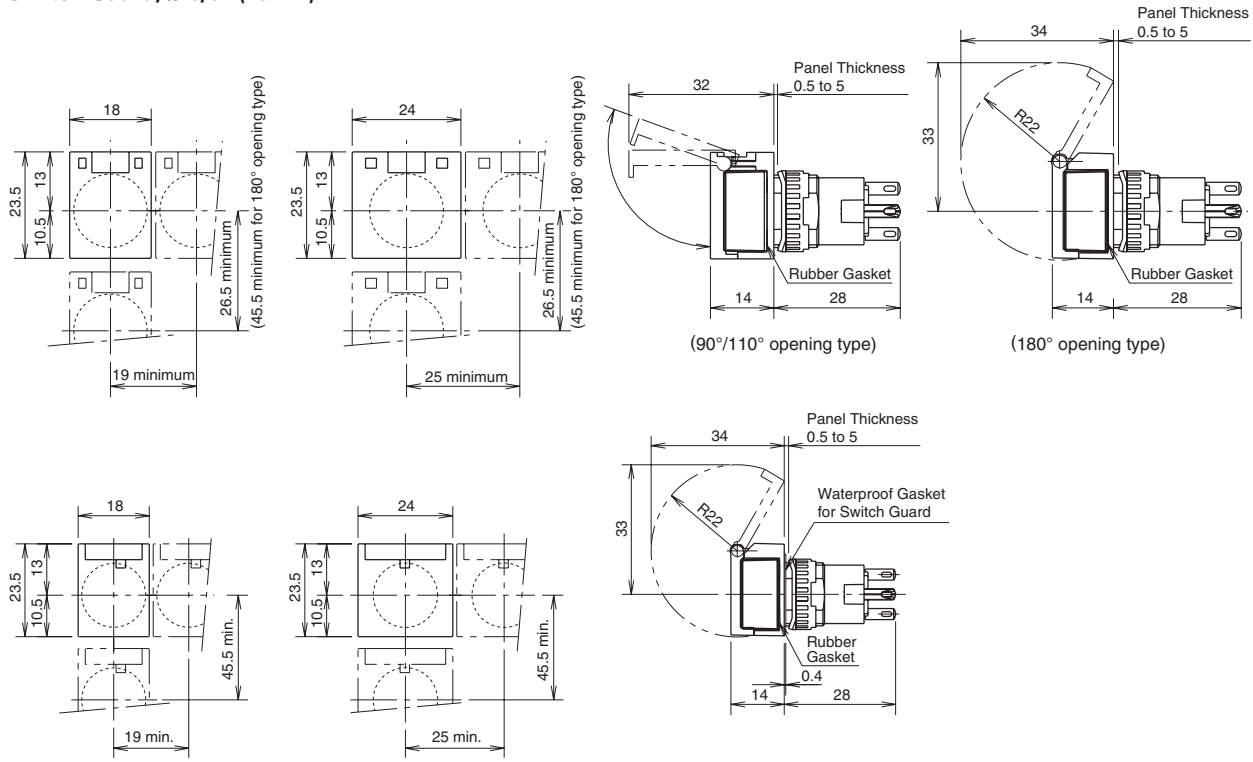

Flush Bezel

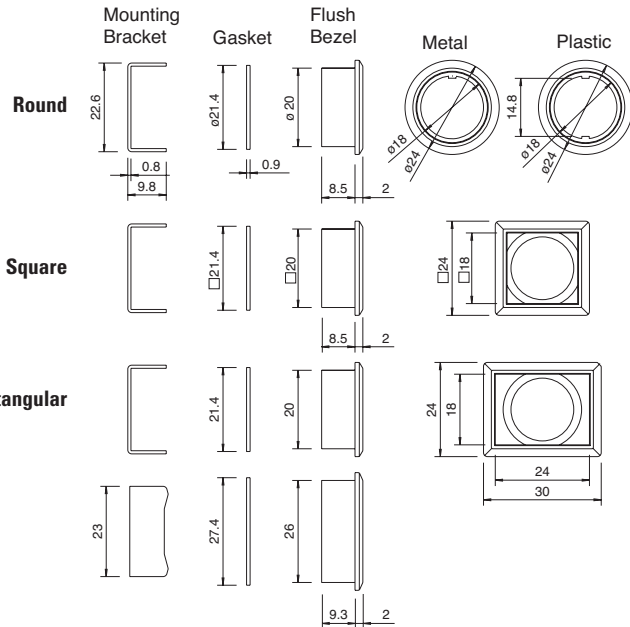

Flush Bezel with Switch

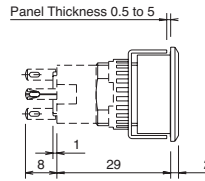

Selector Switches

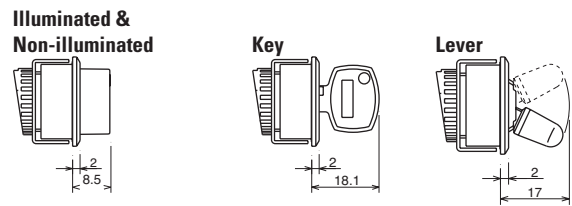

Flush Bezel Mounting Hole Layout

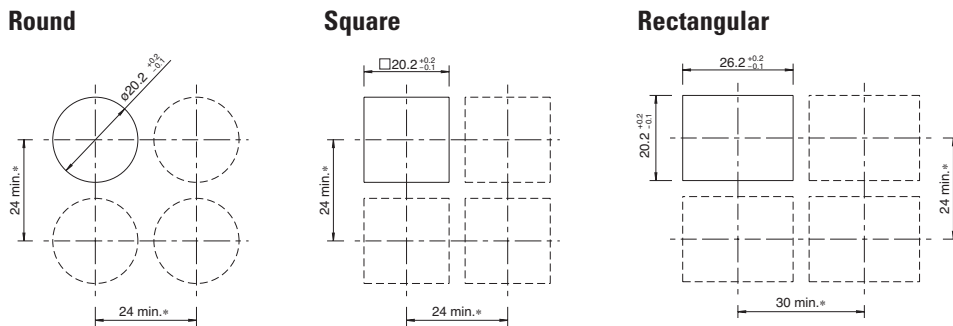

Terminal Sockets

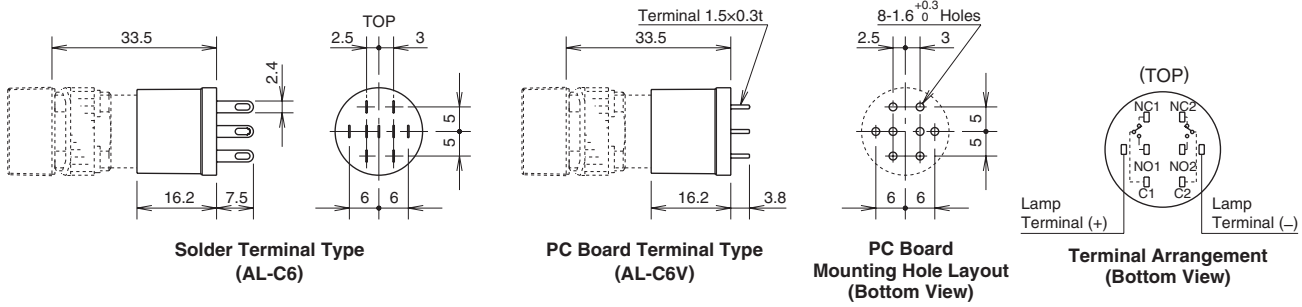

Dust Covers

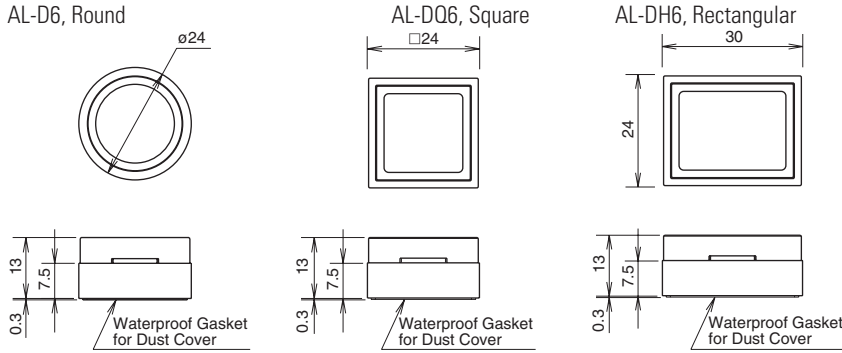

Panel Cut-Outs For Units w/Dust Cover

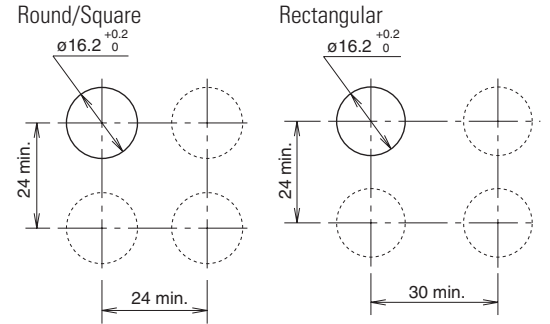

Marking Plates

Pushbuttons with Standard Size Lens

Style	Round—AL6M-W	Square—AL6Q-W	Rectangular—AL6H-W
Dimensions			
	$\phi 5/8"$ (16mm)		
Outside (OD)	(13.8mm)	(13.8mm)	(OD ¹ x OD ²) 13.8 x 19.8mm
Marking Area (a)	(12mm)	(12mm)	(a ¹ x a ²) 12 x 18mm

Pushbuttons with Oversize Lens

Style	Round—AL6M-MW	Square/Rectangular—AL6Q-QW
Dimensions		
Outside (OD)	$\phi 0.491"$ (12.6mm)	0.491" (12.6mm)
Marking Area (a)	$\phi 0.429"$ (11mm)	0.429" (11mm)

Engraving must be made on the engraving area within 0.02" (0.5mm) deep.

Replacing & and Marking Plate

Removal

Remove the lens holder assembly (lens, marking plate and holder) from the operator by holding the color lens recesses with the lens removal tool (Part No.MT-101) and pulling out. Remove marking plate by pushing the color lens from the rear to disengage the latches. Marking plate must be engraved on the side as shown in the figure on the right. $\phi 5/8"$ (16mm)

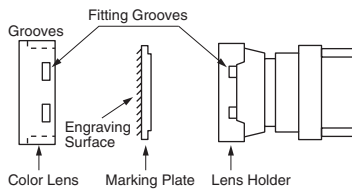

Installation

For illuminated pushbuttons:

1. Insert marking plate inside lens in correct direction
2. Press color lens on to lens holder to engage latches.
3. Insert lens holder into housing in correct direction.

Do not loosen spring on illuminated pushbutton units (except on pilot light units). The marking plate must be engraved on the front side as shown above.